

mitsubishi

CC-Link

System Master/Local Module

User's Manual
(Hardware)

AJ61BT11
A1SJ61BT11

Thank you for buying the Mitsubishi general-purpose programmable controller MELSEC-A Series.

Prior to use, please read both this manual and detailed manual thoroughly and familiarize yourself with the product.



MODEL	AJ61BT11-U-H-JE
MODEL CODE	13JT18
IB(NA)-0800146-D(0907)MEE	

● SAFETY PRECAUTIONS ●

(Read these precautions before using this product.)

Before using this product, please read this manual and the relevant manuals carefully and pay full attention to safety to handle the product correctly.

These precautions apply only to this product.

Refer to the user's manual of the CPU module to use for a description of the programmable controller system safety precautions.

In this manual, the safety precautions are classified into two levels: "DANGER" and "CAUTION".



Indicates that incorrect handling may cause hazardous conditions, resulting in death or severe injury.



Indicates that incorrect handling may cause hazardous conditions, resulting in minor or moderate injury or property damage.

Under some circumstances, failure to observe the precautions given under "**CAUTION**" may lead to serious consequences.

Observe the precautions of both levels because they are important for personal and system safety.

Make sure that the end users read this manual and then keep the manual in a safe place for future reference.

[DESIGN PRECAUTIONS]

DANGER

- For the operating status of each station after a data link failure, refer to Chapter 5 in the user's manual.
- The master station or local station cannot detect errors when a station specified as an error-invalidated station becomes communication error.

CAUTION

- Do not install the control lines or communication cables together with main circuit lines or power cables. Keep a distance of 100mm (3.94 inches) or more between them. Failure to do so may result in malfunction due to noise.

[INSTALLATION PRECAUTIONS]

CAUTION

- Use the programmable controller in an environment that meets the specifications in the user's manual of the CPU module used.
Failure to do so may result in electric shock, fire, malfunction, or damage to or deterioration of the product.
- Insert the tabs at the bottom of the module into the holes in the base unit before mounting the module.
(For the AnS series modules, tighten the screws to the base unit with the specified torque.)
Incorrect mounting may cause malfunction, failure, or drop of the module.
- Shut off the external power supply for the system in all phases before mounting or removing the module.
Failure to do so may result in damage to the product.
- Do not directly touch any conductive part of the module.
Doing so can cause malfunction or failure of the module.

[WIRING PRECAUTIONS]

DANGER

- Shut off the external power supply for the system in all phases before wiring.
Failure to do so may result in electric shock or damage to the product.
- After wiring, attach the included terminal cover to the module before turning it on for operation.
Failure to do so may result in malfunction.

CAUTION

- Tighten the terminal screws within the specified torque range.
Undertightening can cause short circuit, fire, or malfunction.
Overtightening can damage the screw and/or module, resulting in drop, short circuit, or malfunction.
- Prevent foreign matter such as dust or wire chips from entering the module.
Such foreign matter can cause a fire, failure, or malfunction.
- Place the cables in a duct or clamp them.
If not, dangling cables may swing or inadvertently be pulled, resulting in damage to the module or cables or malfunction due to poor contact.
- Do not install the control lines and communication cables together with the main circuit lines or power cables.
Doing so may cause malfunction due to noise.
- Use applicable solderless terminals and tighten them within the specified torque range. If any spade solderless terminal is used, it may be disconnected when the terminal screw comes loose, resulting in failure.

[WIRING PRECAUTIONS]

CAUTION

- When disconnecting the cable from the module, do not pull the cable by the cable part.
When removing the cable with a connector, hold the connector on the side that is connected to the module.
When removing the cable without a connector, loose the screws on the side that is connected to the module.
Pulling the cable that is still connected to the module may result in damage to the module or cable, or malfunction due to poor contact.

[STARTUP AND MAINTENANCE PRECAUTIONS]

DANGER

- Do not touch any terminal while power is on.
Doing so can cause electric shock.
- Shut off the external power supply for the system in all phases before cleaning the module or retightening the terminal screws or module fixing screws.
Failure to do so may result in electric shock.
Undertightening can cause drop of screw, short circuit, or malfunction.
Overtightening can damage the screw and/or module, resulting in drop, short circuit, or malfunction.

CAUTION

- Do not disassemble or modify the modules. Doing so may cause failure, malfunction, injury, or a fire.
- Shut off the external power supply for the system in all phases before mounting or removing the module. Failure to do so may cause the module to fail or malfunction.
- After the first use of the product, do not mount/remove the module to/from the base unit, and the terminal block to/from the module more than 50 times (IEC 61131-2 compliant) respectively.
Exceeding the limit of 50 times may cause malfunction.
- Before handling the module, touch a grounded metal object to discharge the static electricity from the human body.
Failure to do so may cause the module to fail or malfunction.

[DISPOSAL PRECAUTIONS]

CAUTION

- When disposing of this product, treat it as industrial waste.

Revisions

* The manual number is noted at the lower right of the top cover.

Print Date	*Manual Number	Revision
Jul.,2000	IB(NA)-0800146-A	First printing
Mar.,2006	IB(NA)-0800146-B	<div style="border: 1px solid black; padding: 2px; display: inline-block;">Correction</div> SAFETY PRECAUTIONS, Conformation to the EMC Directive and Low Voltage Instruction, Section 1.1, 2.1, 5.1
Aug.,2007	IB(NA)-0800146-C	<div style="border: 1px solid black; padding: 2px; display: inline-block;">Correction</div> Chapter 3, Section 6.1, 6.2
Jul.,2009	IB(NA)-0800146-D	"PLC" was changed to "programmable controller". <div style="border: 1px solid black; padding: 2px; display: inline-block;">Correction</div> SAFETY PRECAUTIONS, Compliance with the EMC and Low Voltage Directives, Section 1.1, 2.1 to 2.2, Chapter 3, 4.1, 5.1, 6.1

This manual confers no industrial property rights or any rights of any other kind, nor does it confer any patent licenses. Mitsubishi electric Corporation cannot be held responsible for any problems involving industrial property rights which may occur as a result of using the contents noted in this manual.

© 2000 MITSUBISHI ELECTRIC CORPORATION

1. Overview	1
1.1 Definition of Ver.1.10	1
2. Performance Specification	2
2.1 Performance specification	2
2.1.1 Maximum overall cable distance	3
2.2 CC-Link dedicated cable	3
3. Name and Setting of Each Component	4
4. Loading and Installation	9
4.1 Handling precautions	9
4.2 Installation environment	9
5. External Wiring	10
5.1 Wiring the CC-Link dedicated cable	10
6. External Dimensions	11
6.1 AJ61BT11	11
6.2 A1SJ61BT11	12

About the Manuals

The following manual is available for this product.
Order as needed, referring to the table below.

Related Manual

Manual name	Manual No. (Model code)
CC-Link System Master/Local Module type AJ61BT11/A1SJ61BT11 User's Manual	IB-66721 (13J872)

Compliance with the EMC and Low Voltage Directives

(1) For programmable controller system

To configure a system meeting the requirements of the EMC and Low Voltage Directives when incorporating the Mitsubishi programmable controller (EMC and Low Voltage Directives compliant) into other machinery or equipment, refer to the "EMC AND LOW VOLTAGE DIRECTIVES" chapter of the user's manual for the CPU module used.

The CE mark, indicating compliance with the EMC and Low Voltage Directives, is printed on the rating plate of the programmable controller.

(2) For the product

For the compliance of this product with the EMC and Low Voltage Directives, refer to the "CC-Link module" section in the "EMC AND LOW VOLTAGE DIRECTIVES" chapter of the user's manual for the CPU module used.

1. Overview

This manual describes the specifications, name of each part, settings, etc., of the AJ61BT11 CC-Link System Master/Local Module (hereafter abbreviated as AJ61BT11) and A1SJ61BT11 CC-Link System Master/Local Module (hereafter abbreviated as A1SJ61BT11) to be used in combination with the MELSEC-A series programmable controller CPU.

Confirm that the following items are included in the package.

Item name		Number of items
AJ61BT11 CC-Link System Master/Local Module	AJ61BT11	1
	Terminating resistor 110Ω 1/2W (Brown-brown-brown)	2
	Terminating resistor 130Ω 1/2W (Brown-orange-brown)	2
A1SJ61BT11 CC-Link System Master/Local Module	A1SJ61BT11	1
	Terminating resistor 110Ω 1/2W (Brown-brown-brown)	2
	Terminating resistor 130Ω 1/2W (Brown-orange-brown)	2

1.1 Definition of Ver.1.10

The module of which the cable length between station and station is uniformly 20cm or more by improving the conventional limit of the cable length between station and station is defined as Ver.1.10.

The conventional modules are defined as Ver.1.00.

The conditions for setting the cable length between station and station uniformly to 20cm or more are indicated below.

- 1) All modules configuring the CC-Link system must use Version 1.10.
- 2) All data link cables must be Version 1.10 compatible CC-Link dedicated cable.

Point
In the case of the system containing modules of both Ver.1.00 and Ver.1.10, the maximum overall cable length and the station-to-station cable length must meet the specifications for Ver.1.00.

(1) Checking Version 1.10

The "CC-Link" logo is printed on the front of the module or on the "rating plate" for the Version 1.10 modules.

The logo for CC-Link, featuring the letters 'CC' in a large, bold, serif font, followed by the word 'Link' in a smaller, italicized serif font.

2. Performance Specification

2.1 Performance specification

The following shows the performance specification of the AJ61BT11 and A1SJ61BT11. Refer to the CPU module User's Manual to be used for general specification of AJ61BT11 and A1SJ61BT11.

Item	Specification
Transmission speed	Selectable from 156kbps/625kbps/2.5Mbps/5Mbps/10Mbps
Maximum overall cable distance (Maximum transmission distance)	Differs according to the transmission speed (Refer to Section 2.1.1)
Maximum number of connected modules (when master station)	64 modules However, the following conditions must be satisfied: $\{(1 \times a) + (2 \times b) + (3 \times c) + (4 \times d)\} \leq 64$ a: Number of modules occupying 1 station. b: Number of modules occupying 2 stations. c: Number of modules occupying 3 stations. d: Number of modules occupying 4 stations. $\{(16 \times A) + (54 \times B) + (88 \times C)\} \leq 2304$ A: Number of remote I/O stations ≤ 64 B: Number of remote device stations ≤ 42 C: Number of local stations, standby master stations, intelligent device stations ≤ 26
Number of occupied stations (when local station)	1 to 4 stations*1 (switched using the DIP switch)
Maximum link points for one system	Remote I/O (RX, RY) : 2048 points Remote register (RWw): 256 points (master station → remote/local station) Remote register (RWr) : 256 points (remote/local station → master station)
Link points for one remote/local station	Remote I/O (RX, RY) : 32 points (local station 30 points) Remote register (RWw): 4 points (master station → remote/local station) Remote register (RWr) : 4 points (remote/local station → master station)
Communication method	Broadcast polling method
Synchronous method	Frame synchronous method
Encoding method	NRZI method
Transmission path	Bus (RS-485)
Transmission format	Conform to HDLC
Error control system	CRC ($X^{16}+X^{12}+X^5+1$)
Cable*2	CC-Link dedicated cable (Ver.1.00)/CC-Link dedicated high-performance cable/Version 1.10 compatible CC-Link dedicated cable
RAS function	<ul style="list-style-type: none"> • Auto return function • Slave station cutoff function • Error detection by the link special relay/register
Number of parameter registration to E ² PROM	10000 times
Number of occupied I/O points	32 points (I/O assignment: special 32 points)
Internal current consumption (5VDC)	AJ61BT11:0.45A, A1SJ61BT11:0.4A
Weight	AJ61BT11:0.4kg , A1SJ61BT11:0.25kg

*1: This setting is applicable to the AJ61BT11 of hardware version F or later and the A1SJ61BT11 of hardware version G or later. For the modules with other versions, the setting is "1 station" and "4 stations" only.

*2: Each of Ver.1.10 compatible CC-Link cables, CC-Link dedicated cables (Ver.1.00), and CC-Link dedicated high-performance cables cannot be used together with other cable types. If different cable types are used together, normal data transmission is not guaranteed. Also attach the terminating resistor which matches the cable. (Refer to section 5.1)

2.1.1 Maximum overall cable distance

The maximum overall cable distance differs according to the transmission speed. For the relationship between the transmission speed and maximum overall cable distance, refer to the CC-Link System Master/Local Module User's Manual.

2.2 CC-Link dedicated cable

Use the CC-Link dedicated cables in a CC-Link system.

If a cable other than the CC-Link dedicated cable is used, the performance of the CC-Link system cannot be guaranteed.

For the specifications of the CC-Link dedicated cables or any other inquiries, visit the following site:

CC-Link Partner Association website: <http://www.cc-link.org/>

REMARK

For details, refer to the CC-Link cable wiring manual issued by CC-Link Partner Association.

3. Name and Setting of Each Component



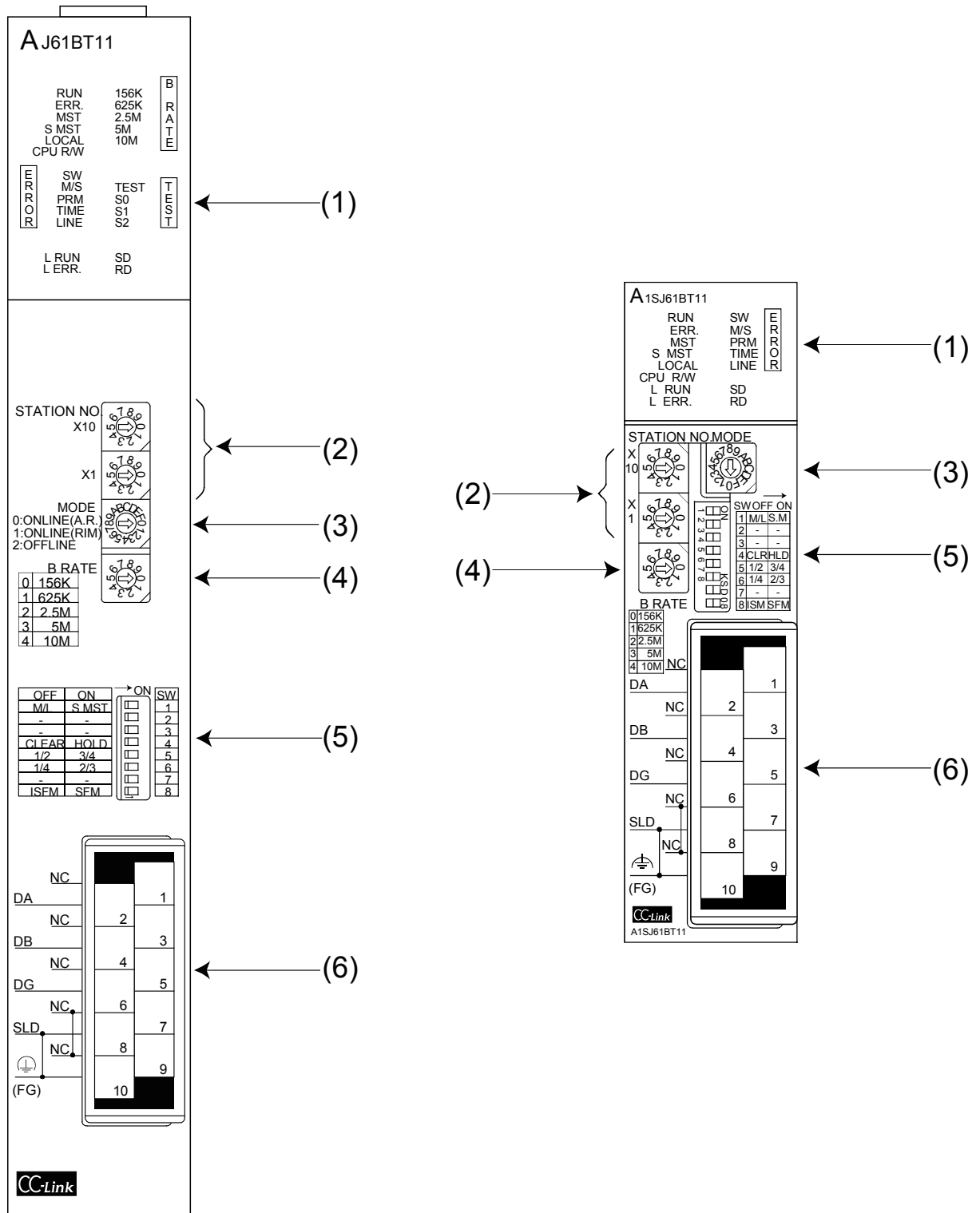



This section explains the name and setting of each component of AJ61BT11 and A1SJ61BT11.



No.	Name	Description																																												
(1)	<div style="border: 1px solid black; padding: 5px; margin-bottom: 10px;"> <p>A J61BT11</p> <table style="width: 100%; border-collapse: collapse;"> <tr> <td style="width: 30%;">RUN</td> <td style="width: 30%;">156K</td> <td rowspan="6" style="width: 10%; text-align: center; vertical-align: middle;">B R A T E</td> </tr> <tr> <td>ERR.</td> <td>625K</td> </tr> <tr> <td>MST</td> <td>2.5M</td> </tr> <tr> <td>S MST</td> <td>5M</td> </tr> <tr> <td>LOCAL</td> <td>10M</td> </tr> <tr> <td>CPU R/W</td> <td></td> </tr> </table> <table style="width: 100%; border-collapse: collapse;"> <tr> <td rowspan="4" style="width: 10%; text-align: center; vertical-align: middle;">E R R O R</td> <td style="width: 30%;">SW</td> <td style="width: 30%;">TEST</td> <td rowspan="4" style="width: 10%; text-align: center; vertical-align: middle;">T E S T</td> </tr> <tr> <td>M/S</td> <td>S0</td> </tr> <tr> <td>PRM</td> <td>S1</td> </tr> <tr> <td>TIME</td> <td>S2</td> </tr> </table> <table style="width: 100%; border-collapse: collapse;"> <tr> <td style="width: 30%;">L RUN</td> <td style="width: 30%;">SD</td> </tr> <tr> <td>L ERR.</td> <td>RD</td> </tr> </table> </div> <div style="border: 1px solid black; padding: 5px;"> <p>A1SJ61BT11</p> <table style="width: 100%; border-collapse: collapse;"> <tr> <td style="width: 30%;">RUN</td> <td style="width: 30%;">SW</td> <td rowspan="6" style="width: 10%; text-align: center; vertical-align: middle;">E R R O R</td> </tr> <tr> <td>ERR.</td> <td>M/S</td> </tr> <tr> <td>MST</td> <td>PRM</td> </tr> <tr> <td>S MST</td> <td>TIME</td> </tr> <tr> <td>LOCAL</td> <td>LINE</td> </tr> <tr> <td>CPU R/W</td> <td></td> </tr> </table> <table style="width: 100%; border-collapse: collapse;"> <tr> <td style="width: 30%;">L RUN</td> <td style="width: 30%;">SD</td> </tr> <tr> <td>L ERR.</td> <td>RD</td> </tr> </table> </div>	RUN	156K	B R A T E	ERR.	625K	MST	2.5M	S MST	5M	LOCAL	10M	CPU R/W		E R R O R	SW	TEST	T E S T	M/S	S0	PRM	S1	TIME	S2	L RUN	SD	L ERR.	RD	RUN	SW	E R R O R	ERR.	M/S	MST	PRM	S MST	TIME	LOCAL	LINE	CPU R/W		L RUN	SD	L ERR.	RD	Data link status can be checked from the LED on status.
		RUN	156K		B R A T E																																									
		ERR.	625K																																											
		MST	2.5M																																											
		S MST	5M																																											
		LOCAL	10M																																											
		CPU R/W																																												
		E R R O R	SW	TEST	T E S T																																									
			M/S	S0																																										
			PRM	S1																																										
			TIME	S2																																										
		L RUN	SD																																											
		L ERR.	RD																																											
		RUN	SW	E R R O R																																										
		ERR.	M/S																																											
		MST	PRM																																											
		S MST	TIME																																											
		LOCAL	LINE																																											
		CPU R/W																																												
		L RUN	SD																																											
		L ERR.	RD																																											
		LED name	Description																																											
		RUN	ON : Module is normal. OFF: Watchdog timer error.																																											
ERR.	ON : Communication error at all stations. Flashing: Communication faulty station exists.																																													
MST	ON: Set as a master station.																																													
S MST	ON: Set as a standby master station.																																													
LOCAL	ON: Set as a local station.																																													
CPU R/W	ON: Communicating with programmable controller CPU. (FROM/TO)																																													
E R R O R	SW	ON: Switch setting error.																																												
	M/S	ON: Master station already exists on the same line. Flashing: Occupied station count overlapping (With the exception of the first station number overlapping)																																												
	PRM	ON: Parameter setting error.																																												
	TIME	ON: Cable disconnection, or no response from all stations due to noise in a communication path.																																												
	LINE	ON Cable disconnection, or transmission path is affected by noise, etc.																																												
	L RUN	ON: In data link. (host) *1																																												
L ERR.	ON: Communication error (host). Flashing at regular intervals: The setting(s) of switches (2) to (5) was changed while the power was on. *2 Flashing at irregular intervals: Terminating resistor is not connected, or module and/or CC-Link dedicated cable is affected by noise.																																													
B R A T E	156K	ON: Transmission speed is set to "156kbps".																																												
	625K	ON: Transmission speed is set to "625kbps".																																												
	2.5M	ON: Transmission speed is set to "2.5Mbps".																																												
	5M	ON: Transmission speed is set to "5Mbps".																																												
	10M	ON: Transmission speed is set to "10Mbps".																																												
T E S T	TEST	ON: Offline test in progress.																																												
	S0	(Not used)																																												
	S1																																													
	S2																																													
SD	ON: Sending data.																																													
RD	ON: Receiving data.																																													

*1: When the module is operated in the synchronous mode, the LED may be lit dimly.

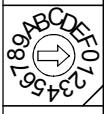
*2: When all stations are in error, changes on switches may not be detected.

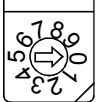
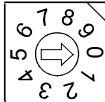
No.	Name	Description																																		
(2)	Station number setting switch AJ61BT11 STATION NO. X10  X1  A1SJ61BT11 STATION NO. X10  X1 	Set the module station number.(setting at shipment: 0) <Range> <ul style="list-style-type: none"> In the remote net mode <ul style="list-style-type: none"> Master station: 0 Local station: 1 to 64 Standby master station: 1 to 63 The "SW" and "L ERR." LEDs are turned on when a value other than 0 to 64 is set. In the remote I/O net mode <ul style="list-style-type: none"> Master station: 1 to 64 (set the last station number of remote I/O station) When set to 0, the "PLM" LED is turned on. 																																		
(3)	Mode setting switches AJ61BT11 MODE 0:ONLINE(A.R.) 1:ONLINE(RIM) 2:OFFLINE  A1SJ61BT11 MODE 	Set the module operation status. (setting at shipment: 0) <table border="1"> <thead> <tr> <th>Number</th> <th>Name</th> </tr> </thead> <tbody> <tr> <td>0</td> <td>Online (remote net mode)</td> </tr> <tr> <td>1</td> <td>Online (remote I/O net mode)</td> </tr> <tr> <td>2</td> <td>Offline</td> </tr> <tr> <td>3</td> <td>Line test 1 *3</td> </tr> <tr> <td>4</td> <td>Line test 2 *3</td> </tr> <tr> <td>5</td> <td>Parameter confirmation test *3</td> </tr> <tr> <td>6</td> <td>Hardware test</td> </tr> <tr> <td>7</td> <td>Setting error (the "SW" LED on)</td> </tr> <tr> <td>8 to A</td> <td>Setting prohibited</td> </tr> <tr> <td>B to F</td> <td>Setting error (the "SW" LED on)</td> </tr> </tbody> </table>	Number	Name	0	Online (remote net mode)	1	Online (remote I/O net mode)	2	Offline	3	Line test 1 *3	4	Line test 2 *3	5	Parameter confirmation test *3	6	Hardware test	7	Setting error (the "SW" LED on)	8 to A	Setting prohibited	B to F	Setting error (the "SW" LED on)												
Number	Name																																			
0	Online (remote net mode)																																			
1	Online (remote I/O net mode)																																			
2	Offline																																			
3	Line test 1 *3																																			
4	Line test 2 *3																																			
5	Parameter confirmation test *3																																			
6	Hardware test																																			
7	Setting error (the "SW" LED on)																																			
8 to A	Setting prohibited																																			
B to F	Setting error (the "SW" LED on)																																			
(4)	Transmission speed setting switch AJ61BT11 B RATE  <table border="1"> <tbody> <tr> <td>0</td> <td>156K</td> </tr> <tr> <td>1</td> <td>625K</td> </tr> <tr> <td>2</td> <td>2.5M</td> </tr> <tr> <td>3</td> <td>5M</td> </tr> <tr> <td>4</td> <td>10M</td> </tr> </tbody> </table> A1SJ61BT11  B RATE <table border="1"> <tbody> <tr> <td>0</td> <td>156K</td> </tr> <tr> <td>1</td> <td>625K</td> </tr> <tr> <td>2</td> <td>2.5M</td> </tr> <tr> <td>3</td> <td>5M</td> </tr> <tr> <td>4</td> <td>10M</td> </tr> </tbody> </table>	0	156K	1	625K	2	2.5M	3	5M	4	10M	0	156K	1	625K	2	2.5M	3	5M	4	10M	Set the module transmission speed. (setting at shipment: 0) <table border="1"> <thead> <tr> <th>Number</th> <th>Setting detail</th> </tr> </thead> <tbody> <tr> <td>0</td> <td>156kbps</td> </tr> <tr> <td>1</td> <td>625kbps</td> </tr> <tr> <td>2</td> <td>2.5Mbps</td> </tr> <tr> <td>3</td> <td>5Mbps</td> </tr> <tr> <td>4</td> <td>10Mbps</td> </tr> <tr> <td>5 to 9</td> <td>Setting error (the "SW" and "L ERR" LED on)</td> </tr> </tbody> </table>	Number	Setting detail	0	156kbps	1	625kbps	2	2.5Mbps	3	5Mbps	4	10Mbps	5 to 9	Setting error (the "SW" and "L ERR" LED on)
0	156K																																			
1	625K																																			
2	2.5M																																			
3	5M																																			
4	10M																																			
0	156K																																			
1	625K																																			
2	2.5M																																			
3	5M																																			
4	10M																																			
Number	Setting detail																																			
0	156kbps																																			
1	625kbps																																			
2	2.5Mbps																																			
3	5Mbps																																			
4	10Mbps																																			
5 to 9	Setting error (the "SW" and "L ERR" LED on)																																			

*3: Use impossible at local station.

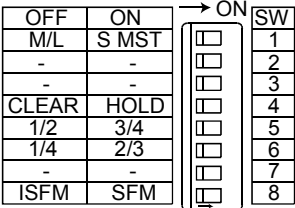
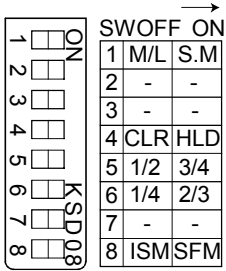
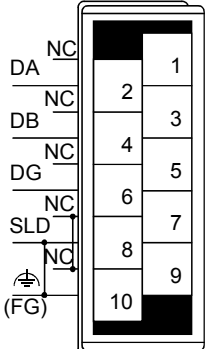
No.	Name	Description				
(5)	Condition setting switch AJ61BT11  A1SJ61BT11 	Set the operation condition. (setting at shipment: SW1 to 7 are OFF, SW8 is ON)				
		Number	Setting detail	Description		
		SW1	Station type	OFF: Master station/Local station ON : Standby master station		
		SW2	(Unusable)	Always off		
		SW3	(Unusable)	Always off		
		SW4	Input data status of the data link error station	OFF: Clear ON : Hold		
		SW5 SW6	Number of occupied stations	Number of occupied stations	SW5	SW6
				1 station	OFF	OFF
				2 stations*4	OFF	ON
				3 stations*4	ON	ON
	4 stations	ON	OFF			
SW7	(Unusable)	Always off				
SW8	Module mode	OFF: Intelligent mode ON : I/O mode				
(6)	Terminal block 	Connect the CC-Link dedicated cable for data link. Refer to Section 5.1 for how to connect the cables. Note that the following terminals are connected inside the module. <ul style="list-style-type: none"> • SLD (terminal No. 8) and FG (terminal No. 10) • NC (terminal No. 7) and NC (terminal No. 9) 2-piece type terminal block. The module can be exchanged with another without removing the signal lines from the terminal block. (Replace the module after turning off its power.)				

*4: The AJ61BT11 of hardware version F or later and the A1SJ61BT11 of hardware version G or later are compatible with this setting.
 For other than the above, only SW5 is used to set the number of occupied stations.
 OFF : 1 station occupied
 ON : 4 stations occupied
 Keep SW6 OFF as it is unusable.

Point

The setting for the switches (2) to (5) when the module power supply is turned OFF → ON is valid.

When the setting is changed while the module power supply is on, reset the programmable controller CPU or turn off and then on the module power supply again.

Important

Do not use station number 64 in a system where the waiting master station exists.

When it is used, the station number 64 will not communicate correctly.

4. Loading and Installation

The following is explanations of the handling precautions and installation environment, which is common to modules when handling AJ61BT11 and A1SJ61BT11 from unpacking to installation.

For the details of loading and installation of the module, refer to the user's manual of the programmable controller CPU module used.

4.1 Handling precautions

The following is an explanation of handling precautions of the module.

- (1) Do not drop the module case or terminal block, or subject them to heavy impact since they are made of resin.
- (2) Do not remove the print circuit board of each module from its case. This may cause a failure in the module.
- (3) Prevent foreign matter such as dust or wire chips from entering the module. Such foreign matter can cause a fire, failure, or malfunction.
- (4) Solderless terminals with insulation sleeve cannot be used for the terminal block. It is recommended that the wiring connecting sections of the solderless terminals will be covered with a marking tube or an insulation tube.
- (5) Before handling the module, touch a grounded metal object to discharge the static electricity from the human body.
Failure to do so may cause the module to fail or malfunction.
- (6) Tighten the module mounting screws and terminal screws within the following torque range.

Screw location	Tightening torque range
Module mounting screws (M4 screws)	0.78 to 1.18N·m
Terminal-block terminal screws (M3.5 screws)	0.59 to 0.88N·m
Terminal-block installation screws (M3.5 screws)	0.49 to 0.78N·m

- (7) Insert the tabs at the bottom of the module into the holes in the base unit before mounting the module. (For the AnS series modules, make sure screws are securely tightened to the base unit with the specified torque.)
Incorrect mounting may cause malfunction, failure, or drop of the module.

Point
(1) Turn off the power supply to the applicable station before mounting or removing the terminal block. If the terminal block is mounted or removed without turning off the power supply to the applicable station, correct data transmission cannot be guaranteed.
(2) Power off the system in advance when removing the terminating resistor to change the system. If the terminating resistor is removed and mounted while the system is energized, normal data transmission will not be guaranteed.

4.2 Installation environment

Refer to the user's manual of the programmable controller CPU module used.

5. External Wiring

5.1 Wiring the CC-Link dedicated cable

The connection method of the CC-Link dedicated cables for the master module, local module, standby master module, remote module and intelligent module are described.

- (1) Ver.1.10-compatible CC-Link dedicated cables, CC-Link dedicated cables (Ver.1.00), and CC-Link dedicated high-performance cables cannot be used together. If used together, correct data transmission will not be guaranteed.
- (2) CC-Link cables can be connected from any station number.
- (3) Connect the shielded wire of the CC-Link dedicated cable to "SLD" of each module, and ground both ends of the shielded wire to the protective ground conductor via "FG".

The SLD and FG are connected within the module.

- (4) Connect the "terminating resistors" supplied with each module at both ends of the CC-Link system.

Connect the terminating resistors across "DA" and "DB".

When a T-branch system is configured, some restrictions are applied to the use of the A(1S)J61BT11/A(1S)J61QBT11 as the master station. Refer to the CC-Link System Master/Local Module User's Manual for details.

- (5) The terminating resistors to be connected vary depending on the cable type used in the CC-Link system.

Cable type	Terminating resistor
CC-Link dedicated cable	110 1/2 W
Version 1.10 compatible CC-Link dedicated cable	(brown-brown-brown)
CC-Link dedicated high-performance cable	130 1/2 W
	(brown-orange-brown)

- (6) The master module can be connected at other points than both ends.
- (7) Star connection is not allowed.
- (8) The connection method is shown below.

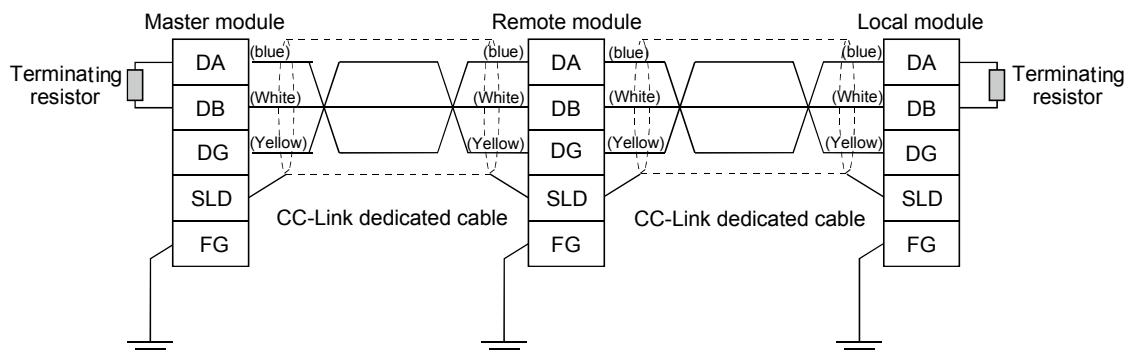

6. External Dimensions

6.1 AJ61BT11

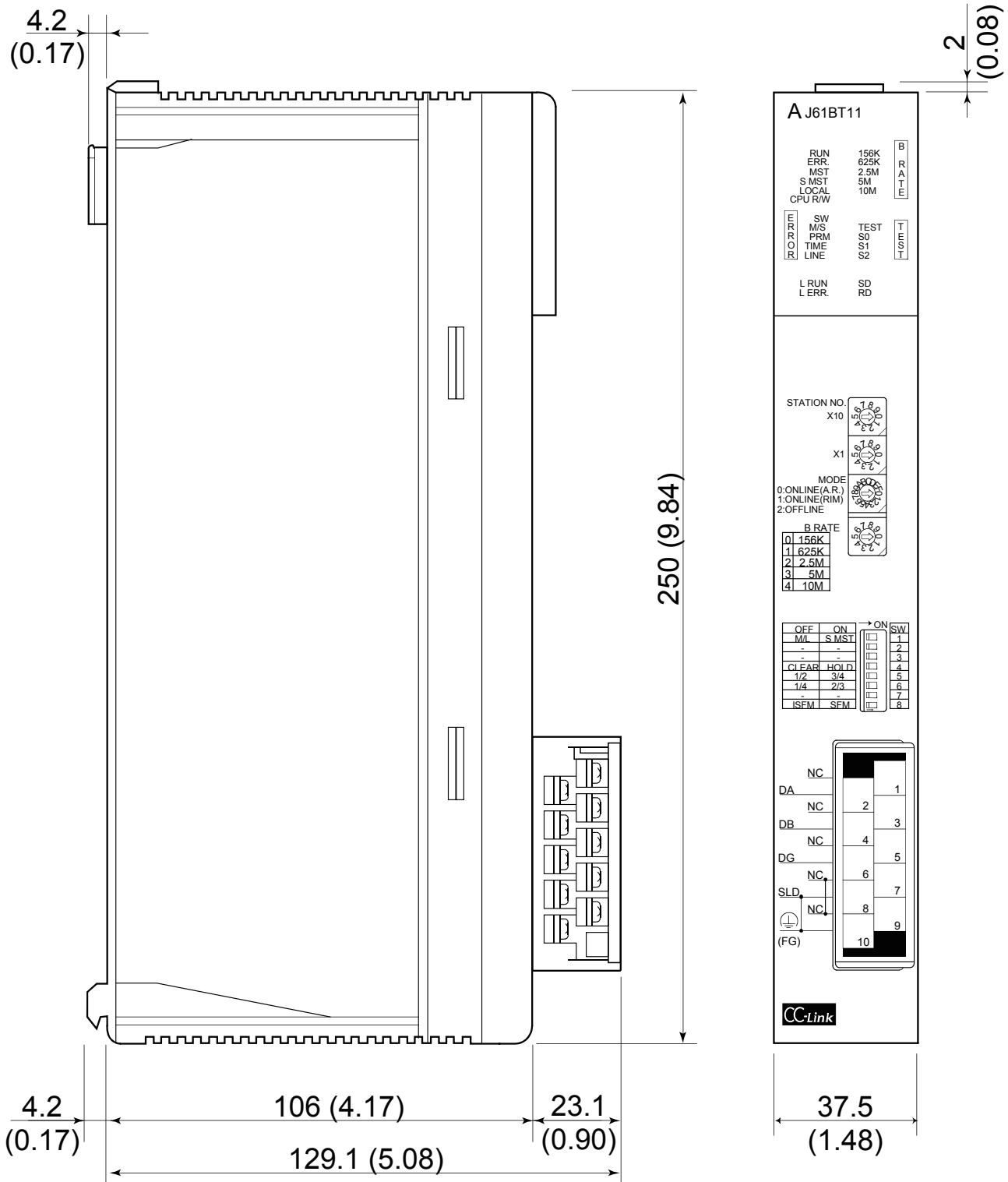

Unit: mm (inch)

6.2 A1SJ61BT11

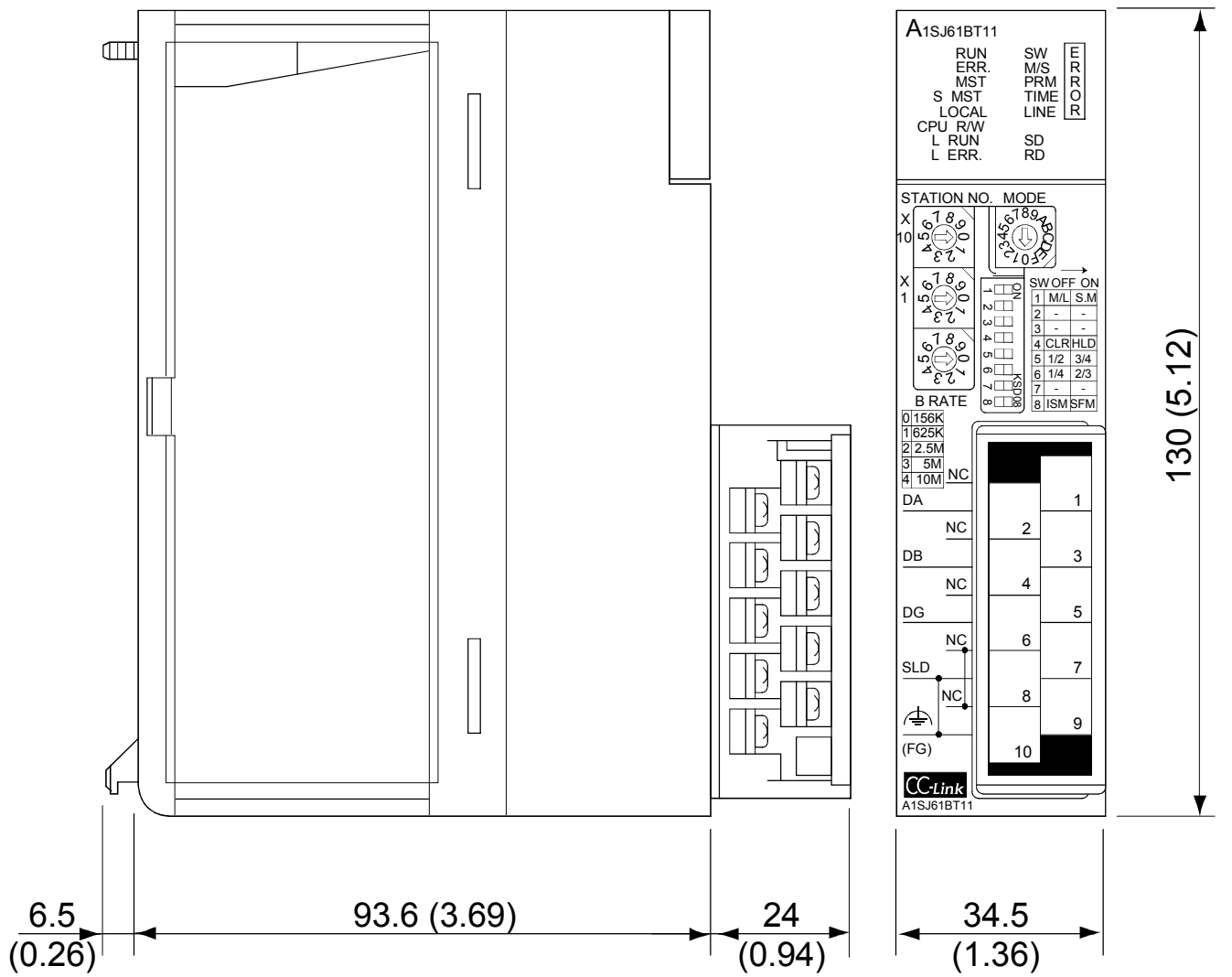

Unit: mm (inch)

Warranty

Mitsubishi will not be held liable for damage caused by factors found not to be the cause of Mitsubishi; machine damage or lost profits caused by faults in the Mitsubishi products; damage, secondary damage, accident compensation caused by special factors unpredictable by Mitsubishi; damages to products other than Mitsubishi products; and to other duties.

For safe use

- This product has been manufactured as a general-purpose part for general industries, and has not been designed or manufactured to be incorporated in a device or system used in purposes related to human life.
- Before using the product for special purposes such as nuclear power, electric power, aerospace, medicine or passenger movement vehicles, consult with Mitsubishi.
- This product has been manufactured under strict quality control. However, when installing the product where major accidents or losses could occur if the product fails, install appropriate backup or failsafe functions in the system.

Country/Region	Sales office/Tel	Country/Region	Sales office/Tel
U.S.A	Mitsubishi Electric Automation Inc. 500 Corporate Woods Parkway Vernon Hills, IL 60061, U.S.A. Tel : +1-847-478-2100	Hong Kong	Mitsubishi Electric Automation (Hong Kong) Ltd. 10th Floor, Manulife Tower, 169 Electric Road, North Point, Hong Kong Tel : +852-2887-8870
Brazil	MELCO-TEC Rep. Com.e Assessoria Tecnica Ltda. Rua Correia Dias, 184, Edificio Paraiso Trade Center-8 andar Paraiso, Sao Paulo, SP Brazil Tel : +55-11-5908-8331	China	Mitsubishi Electric Automation (Shanghai) Ltd. 4/F Zhi Fu Plazz, No.80 Xin Chang Road, Shanghai 200003, China Tel : +86-21-6120-0808
Germany	Mitsubishi Electric Europe B.V. German Branch Gothaer Strasse 8 D-40880 Ratingen, GERMANY Tel : +49-2102-486-0	Taiwan	Setsuyo Enterprise Co., Ltd. 6F No.105 Wu-Kung 3rd.Rd, Wu-Ku Hsiang, Taipei Hsine, Taiwan Tel : +886-2-2299-2499
U.K	Mitsubishi Electric Europe B.V. UK Branch Travellers Lane, Hatfield, Hertfordshire., AL10 8XB, U.K. Tel : +44-1707-276100	Korea	Mitsubishi Electric Automation Korea Co., Ltd. 1480-6, Gayang-dong, Gangseo-ku Seoul 157-200, Korea Tel : +82-2-3660-9552
Italy	Mitsubishi Electric Europe B.V. Italian Branch Centro Dir. Colleoni, Pal. Perseo-Ingr.2 Via Paracelso 12, I-20041 Agrate Brianza., Milano, Italy Tel : +39-039-60531	Singapore	Mitsubishi Electric Asia Pte, Ltd. 307 Alexandra Road #05-01/02, Mitsubishi Electric Building, Singapore 159943 Tel : +65-6470-2460
Spain	Mitsubishi Electric Europe B.V. Spanish Branch Carretera de Rubi 76-80, E-08190 Sant Cugat del Valles, Barcelona, Spain Tel : +34-93-565-3131	Thailand	Mitsubishi Electric Automation (Thailand) Co., Ltd. Bang-Chan Industrial Estate No.111 Moo 4, Serithai Rd, T.Kannayao, A.Kannayao, Bangkok 10230 Thailand Tel : +66-2-517-1326
France	Mitsubishi Electric Europe B.V. French Branch 25, Boulevard des Bouvets, F-92741 Nanterre Cedex, France TEL: +33-1-5568-5568	Indonesia	P.T. Autoteknindo Sumber Makmur Muara Karang Selatan, Block A/Utara No.1 Kav. No.11 Kawasan Industri Pergudangan Jakarta - Utara 14440, P.O.Box 5045 Jakarta, 11050 Indonesia Tel : +62-21-6630833
South Africa	Circuit Breaker Industries Ltd. Private Bag 2016, ZA-1600 Isando, South Africa Tel : +27-11-928-2000	India	Messung Systems Pvt, Ltd. Electronic Sadan NO:III Unit No15, M.I.D.C Bhosari, Pune-411026, India Tel : +91-20-2712-3130
		Australia	Mitsubishi Electric Australia Pty. Ltd. 348 Victoria Road, Rydalmere, N.S.W 2116, Australia Tel : +61-2-9684-7777

MITSUBISHI ELECTRIC CORPORATION

HEAD OFFICE : TOKYO BUILDING, 2-7-3 MARUNOUCHI, CHIYODA-KU, TOKYO 100-8310, JAPAN
NAGOYA WORKS : 1-14, YADA-MINAMI 5-CHOME, HIGASHI-KU, NAGOYA, JAPAN

When exported from Japan, this manual does not require application to the Ministry of Economy, Trade and Industry for service transaction permission.

Specifications subject to change without notice.
Printed in Japan on recycled paper.